

UTAH



Miniature adjustable projector range. Contemporary simplicity and a diminutive footprint allows designers to paint landscaping with light whilst avoiding visual clutter.

Luminaire Structure

- Die-cast aluminium housing pre-treated before powder coating ensuring high corrosion resistance
- Single entry
- One cable gland supplied with 0.5 m of 2x0.5 sqmm outdoor cable
- Stainless steel fasteners in grade 316
- Durable silicone rubber gasket
- High-efficiency PMMA lens
- Clear toughened glass
- Include control gear for UT-50571, UT-50572
- Remote driver is not included for UT-50552, UT-50553, UT-50555, UT-50562, UT-50563, UT-50565
- Plastic ground spike for garden type



Feature Symbols

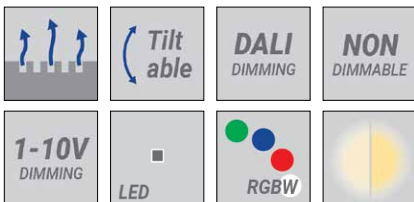

Light Symbols



Product colors















UTAH

Technical information

Model No.	Lamp	Power	Lumen	Optic					CCT	Dimming type	Efficacy	EEC	CRI	Weight	
				N	M	W	VW	E							
With driver / spike / anti-glare visor - 230V 50/60Hz - Class I															
UTAH ECO 1	UT-50572	1 LED	7 W	315 lm	-	30°	45°	60°	-	3000K, 4000K	1-10V, DALI, On/Off	42 - 45 lm/W	A++	-	0.27 kg.
Without remote driver / IP box - Constant voltage (CV) 24V - Class III															
UTAH 1	UT-50552	1 LED	2 W	164 lm	23°	-	-	-	-	3000K, 4000K	DMX	80 - 82 lm/W	A++	-	0.27 kg.
Without remote driver / IP box - Constant current (CC) 500mA, 3V - Class III															
UTAH 1	UT-50553	1 LED	2 W	164 lm	23°	-	-	-	-	3000K, 4000K	1-10V, DALI, On/Off	40 - 41 lm/W	A++	-	0.27 kg.
Without remote driver / IP box - Constant voltage (CV) 24V - Class III - RGBW															
UTAH 3	UT-50555	1 LED	5 W	195 lm	18°	33°	50°	-	23°x 43°	RGBW 30, 40	On/Off	40 - 45 lm/W	A++	-	0.27 kg.
Without remote driver / IP box - With spike - Constant voltage (CV) 24V - Class III															
UTAH 2	UT-50562	1 LED	2 W	164 lm	23°	-	-	-	-	3000K, 4000K	On/Off	80 - 82 lm/W	A++	-	0.27 kg.
Without remote driver / IP box - With spike - Constant current (CC) 500mA, 3V - Class III															
UTAH 2	UT-50563	1 LED	2 W	164 lm	23°	-	-	-	-	3000K, 4000K	DMX	80 - 82 lm/W	A++	-	0.27 kg.
Without remote driver / IP box - With spike - Constant voltage (CV) 24V - Class III - RGBW															
UTAH 4	UT-50565	1 LED	5 W	195 lm	18°	33°	50°	-	23°x 43°	RGBW 30, 40	On/Off	40 - 45 lm/W	A++	-	0.27 kg.

Accessories

						
	Driver ND 20W - IP20 - Constant Voltage - 24V	Driver ND 50W - IP20 - Constant Voltage - 24V	Driver ND 100W - IP20 - Constant Voltage - 24V	Driver ND 150W - IP20 - Constant Voltage - 24V	Driver ND 200W - IP20 - Constant Voltage - 24V	Driver ND 350W - IP20 - Constant Voltage - 24V
	A32091-ND	A32191-ND	A32291-ND	A32391-ND	A32491-ND	A32591-ND
UT-50552
UT-50553
UT-50562
UT-50563
UT-50555
UT-50565
UT-50572

							
	Driver DA 20W - IP20 - Constant Current - 700mA max	Driver DI 20W - IP20 - Constant Current - 700mA max	Driver ND 20W - IP20 - Constant Current - 700mA max	Anti glare visor	SLESA-U9	SLESA-UE7	STICK-KE1
	A32691-DA	A32691-DI	A32691-ND	A51431	A60491	A60691	A60791
UT-50552
UT-50553
UT-50562
UT-50563
UT-50555
UT-50565
UT-50572

UTAH

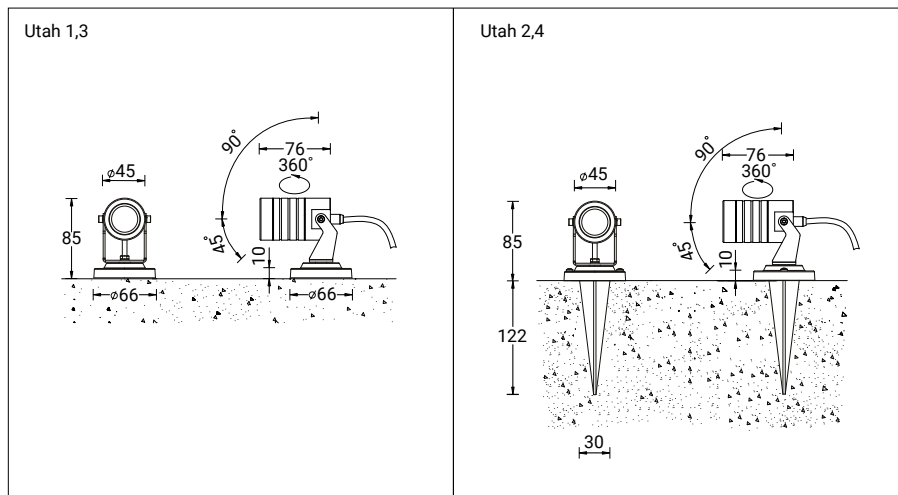

Format Reference	Format Name
UT-50552-N-W30-DA-03	UTAH 1 - UT-50552 - 1 LED - 2 W - 23° - 3000K - DALI - White
UT-50552-N-W40-DA-03	UTAH 1 - UT-50552 - 1 LED - 2 W - 23° - 4000K - DALI - White
UT-50552-N-W30-DA-02	UTAH 1 - UT-50552 - 1 LED - 2 W - 23° - 3000K - DALI - Dark Grey
UT-50552-N-W40-DA-02	UTAH 1 - UT-50552 - 1 LED - 2 W - 23° - 4000K - DALI - Dark Grey
UT-50552-N-W30-ND-02	UTAH 1 - UT-50552 - 1 LED - 2 W - 23° - 3000K - On/Off - Dark Grey
UT-50552-N-W40-ND-02	UTAH 1 - UT-50552 - 1 LED - 2 W - 23° - 4000K - On/Off - Dark Grey
UT-50552-N-W30-DI-02	UTAH 1 - UT-50552 - 1 LED - 2 W - 23° - 3000K - 1-10V - Dark Grey
UT-50552-N-W40-DI-02	UTAH 1 - UT-50552 - 1 LED - 2 W - 23° - 4000K - 1-10V - Dark Grey
UT-50552-N-W30-DI-06	UTAH 1 - UT-50552 - 1 LED - 2 W - 23° - 3000K - 1-10V - Bronze
UT-50552-N-W40-DI-06	UTAH 1 - UT-50552 - 1 LED - 2 W - 23° - 4000K - 1-10V - Bronze
UT-50552-N-W30-ND-05	UTAH 1 - UT-50552 - 1 LED - 2 W - 23° - 3000K - On/Off - Matt Silver
UT-50552-N-W40-ND-05	UTAH 1 - UT-50552 - 1 LED - 2 W - 23° - 4000K - On/Off - Matt Silver
UT-50552-N-W30-ND-01	UTAH 1 - UT-50552 - 1 LED - 2 W - 23° - 3000K - On/Off - Black
UT-50552-N-W40-ND-01	UTAH 1 - UT-50552 - 1 LED - 2 W - 23° - 4000K - On/Off - Black
UT-50552-N-W30-DA-06	UTAH 1 - UT-50552 - 1 LED - 2 W - 23° - 3000K - DALI - Bronze
UT-50552-N-W40-DA-06	UTAH 1 - UT-50552 - 1 LED - 2 W - 23° - 4000K - DALI - Bronze
UT-50552-N-W30-ND-06	UTAH 1 - UT-50552 - 1 LED - 2 W - 23° - 3000K - On/Off - Bronze
UT-50552-N-W40-ND-06	UTAH 1 - UT-50552 - 1 LED - 2 W - 23° - 4000K - On/Off - Bronze
UT-50552-N-W30-ND-03	UTAH 1 - UT-50552 - 1 LED - 2 W - 23° - 3000K - On/Off - White
UT-50552-N-W40-ND-03	UTAH 1 - UT-50552 - 1 LED - 2 W - 23° - 4000K - On/Off - White
UT-50552-N-W30-DA-05	UTAH 1 - UT-50552 - 1 LED - 2 W - 23° - 3000K - DALI - Matt Silver
UT-50552-N-W40-DA-05	UTAH 1 - UT-50552 - 1 LED - 2 W - 23° - 4000K - DALI - Matt Silver
UT-50552-N-W30-DI-05	UTAH 1 - UT-50552 - 1 LED - 2 W - 23° - 3000K - 1-10V - Matt Silver
UT-50552-N-W40-DI-05	UTAH 1 - UT-50552 - 1 LED - 2 W - 23° - 4000K - 1-10V - Matt Silver
UT-50552-N-W30-DI-01	UTAH 1 - UT-50552 - 1 LED - 2 W - 23° - 3000K - 1-10V - Black
UT-50552-N-W40-DI-01	UTAH 1 - UT-50552 - 1 LED - 2 W - 23° - 4000K - 1-10V - Black
UT-50552-N-W30-DI-03	UTAH 1 - UT-50552 - 1 LED - 2 W - 23° - 3000K - 1-10V - White
UT-50552-N-W40-DI-03	UTAH 1 - UT-50552 - 1 LED - 2 W - 23° - 4000K - 1-10V - White
UT-50552-N-W30-DA-01	UTAH 1 - UT-50552 - 1 LED - 2 W - 23° - 3000K - DALI - Black
UT-50552-N-W40-DA-01	UTAH 1 - UT-50552 - 1 LED - 2 W - 23° - 4000K - DALI - Black
UT-50553-N-W30-DI-06	UTAH 1 - UT-50553 - 1 LED - 4 W - 23° - 3000K - 1-10V - Bronze
UT-50553-N-W40-DI-06	UTAH 1 - UT-50553 - 1 LED - 4 W - 23° - 4000K - 1-10V - Bronze
UT-50553-N-W30-DI-01	UTAH 1 - UT-50553 - 1 LED - 4 W - 23° - 3000K - 1-10V - Black
UT-50553-N-W40-DI-01	UTAH 1 - UT-50553 - 1 LED - 4 W - 23° - 4000K - 1-10V - Black
UT-50553-N-W30-DA-05	UTAH 1 - UT-50553 - 1 LED - 4 W - 23° - 3000K - DALI - Matt Silver
UT-50553-N-W40-DA-05	UTAH 1 - UT-50553 - 1 LED - 4 W - 23° - 4000K - DALI - Matt Silver
UT-50553-N-W30-ND-03	UTAH 1 - UT-50553 - 1 LED - 4 W - 23° - 3000K - On/Off - White
UT-50553-N-W40-ND-03	UTAH 1 - UT-50553 - 1 LED - 4 W - 23° - 4000K - On/Off - White

UTAH

UT-50553-N-W30-DA-06	UTAH 1 - UT-50553 - 1 LED - 4 W - 23° - 3000K - DALI - Bronze
UT-50553-N-W40-DA-06	UTAH 1 - UT-50553 - 1 LED - 4 W - 23° - 4000K - DALI - Bronze
UT-50553-N-W30-DI-02	UTAH 1 - UT-50553 - 1 LED - 4 W - 23° - 3000K - 1-10V - Dark Grey
UT-50553-N-W40-DI-02	UTAH 1 - UT-50553 - 1 LED - 4 W - 23° - 4000K - 1-10V - Dark Grey
UT-50553-N-W30-ND-02	UTAH 1 - UT-50553 - 1 LED - 4 W - 23° - 3000K - On/Off - Dark Grey
UT-50553-N-W40-ND-02	UTAH 1 - UT-50553 - 1 LED - 4 W - 23° - 4000K - On/Off - Dark Grey
UT-50553-N-W30-DI-03	UTAH 1 - UT-50553 - 1 LED - 4 W - 23° - 3000K - 1-10V - White
UT-50553-N-W40-DI-03	UTAH 1 - UT-50553 - 1 LED - 4 W - 23° - 4000K - 1-10V - White
UT-50553-N-W30-DI-05	UTAH 1 - UT-50553 - 1 LED - 4 W - 23° - 3000K - 1-10V - Matt Silver
UT-50553-N-W40-DI-05	UTAH 1 - UT-50553 - 1 LED - 4 W - 23° - 4000K - 1-10V - Matt Silver
UT-50553-N-W30-ND-06	UTAH 1 - UT-50553 - 1 LED - 4 W - 23° - 3000K - On/Off - Bronze
UT-50553-N-W40-ND-06	UTAH 1 - UT-50553 - 1 LED - 4 W - 23° - 4000K - On/Off - Bronze
UT-50553-N-W30-ND-05	UTAH 1 - UT-50553 - 1 LED - 4 W - 23° - 3000K - On/Off - Matt Silver
UT-50553-N-W40-ND-05	UTAH 1 - UT-50553 - 1 LED - 4 W - 23° - 4000K - On/Off - Matt Silver
UT-50553-N-W30-ND-01	UTAH 1 - UT-50553 - 1 LED - 4 W - 23° - 3000K - On/Off - Black
UT-50553-N-W40-ND-01	UTAH 1 - UT-50553 - 1 LED - 4 W - 23° - 4000K - On/Off - Black
UT-50553-N-W30-DA-03	UTAH 1 - UT-50553 - 1 LED - 4 W - 23° - 3000K - DALI - White
UT-50553-N-W40-DA-03	UTAH 1 - UT-50553 - 1 LED - 4 W - 23° - 4000K - DALI - White
UT-50553-N-W30-DA-02	UTAH 1 - UT-50553 - 1 LED - 4 W - 23° - 3000K - DALI - Dark Grey
UT-50553-N-W40-DA-02	UTAH 1 - UT-50553 - 1 LED - 4 W - 23° - 4000K - DALI - Dark Grey
UT-50553-N-W30-DA-01	UTAH 1 - UT-50553 - 1 LED - 4 W - 23° - 3000K - DALI - Black
UT-50553-N-W40-DA-01	UTAH 1 - UT-50553 - 1 LED - 4 W - 23° - 4000K - DALI - Black
UT-50562-N-W40-ND-01	UTAH 2 - UT-50562 - 1 LED - 2 W - 23° - 4000K - On/Off - Black
UT-50562-N-W30-ND-01	UTAH 2 - UT-50562 - 1 LED - 2 W - 23° - 3000K - On/Off - Black
UT-50562-N-W40-ND-05	UTAH 2 - UT-50562 - 1 LED - 2 W - 23° - 4000K - On/Off - Matt Silver
UT-50562-N-W30-ND-05	UTAH 2 - UT-50562 - 1 LED - 2 W - 23° - 3000K - On/Off - Matt Silver
UT-50562-N-W40-ND-06	UTAH 2 - UT-50562 - 1 LED - 2 W - 23° - 4000K - On/Off - Bronze
UT-50562-N-W30-ND-06	UTAH 2 - UT-50562 - 1 LED - 2 W - 23° - 3000K - On/Off - Bronze
UT-50562-N-W40-ND-03	UTAH 2 - UT-50562 - 1 LED - 2 W - 23° - 4000K - On/Off - White
UT-50562-N-W30-ND-03	UTAH 2 - UT-50562 - 1 LED - 2 W - 23° - 3000K - On/Off - White
UT-50562-N-W40-ND-02	UTAH 2 - UT-50562 - 1 LED - 2 W - 23° - 4000K - On/Off - Dark Grey
UT-50562-N-W30-ND-02	UTAH 2 - UT-50562 - 1 LED - 2 W - 23° - 3000K - On/Off - Dark Grey
UT-50563-N-W40-DA-01	UTAH 2 - UT-50563 - 1 LED - 2 W - 23° - 4000K - DALI - Black
UT-50563-N-W30-DA-01	UTAH 2 - UT-50563 - 1 LED - 2 W - 23° - 3000K - DALI - Black
UT-50563-N-W40-ND-01	UTAH 2 - UT-50563 - 1 LED - 2 W - 23° - 4000K - On/Off - Black
UT-50563-N-W30-ND-01	UTAH 2 - UT-50563 - 1 LED - 2 W - 23° - 3000K - On/Off - Black
UT-50563-N-W40-DI-02	UTAH 2 - UT-50563 - 1 LED - 2 W - 23° - 4000K - 1-10V - Dark Grey
UT-50563-N-W30-DI-02	UTAH 2 - UT-50563 - 1 LED - 2 W - 23° - 3000K - 1-10V - Dark Grey
UT-50563-N-W40-DI-01	UTAH 2 - UT-50563 - 1 LED - 2 W - 23° - 4000K - 1-10V - Black
UT-50563-N-W30-DI-01	UTAH 2 - UT-50563 - 1 LED - 2 W - 23° - 3000K - 1-10V - Black
UT-50563-N-W40-DA-02	UTAH 2 - UT-50563 - 1 LED - 2 W - 23° - 4000K - DALI - Dark Grey
UT-50563-N-W30-DA-02	UTAH 2 - UT-50563 - 1 LED - 2 W - 23° - 3000K - DALI - Dark Grey
UT-50563-N-W40-DA-03	UTAH 2 - UT-50563 - 1 LED - 2 W - 23° - 4000K - DALI - White
UT-50563-N-W30-DA-03	UTAH 2 - UT-50563 - 1 LED - 2 W - 23° - 3000K - DALI - White
UT-50563-N-W40-DA-05	UTAH 2 - UT-50563 - 1 LED - 2 W - 23° - 4000K - DALI - Matt Silver
UT-50563-N-W30-DA-05	UTAH 2 - UT-50563 - 1 LED - 2 W - 23° - 3000K - DALI - Matt Silver
UT-50563-N-W40-DI-06	UTAH 2 - UT-50563 - 1 LED - 2 W - 23° - 4000K - 1-10V - Bronze
UT-50563-N-W30-DI-06	UTAH 2 - UT-50563 - 1 LED - 2 W - 23° - 3000K - 1-10V - Bronze
UT-50563-N-W40-DI-05	UTAH 2 - UT-50563 - 1 LED - 2 W - 23° - 4000K - 1-10V - Matt Silver
UT-50563-N-W30-DI-05	UTAH 2 - UT-50563 - 1 LED - 2 W - 23° - 3000K - 1-10V - Matt Silver
UT-50563-N-W40-ND-06	UTAH 2 - UT-50563 - 1 LED - 2 W - 23° - 4000K - On/Off - Bronze
UT-50563-N-W30-ND-06	UTAH 2 - UT-50563 - 1 LED - 2 W - 23° - 3000K - On/Off - Bronze
UT-50563-N-W40-ND-02	UTAH 2 - UT-50563 - 1 LED - 2 W - 23° - 4000K - On/Off - Dark Grey
UT-50563-N-W30-ND-02	UTAH 2 - UT-50563 - 1 LED - 2 W - 23° - 3000K - On/Off - Dark Grey
UT-50563-N-W40-ND-03	UTAH 2 - UT-50563 - 1 LED - 2 W - 23° - 4000K - On/Off - White
UT-50563-N-W30-ND-03	UTAH 2 - UT-50563 - 1 LED - 2 W - 23° - 3000K - On/Off - White
UT-50563-N-W40-ND-05	UTAH 2 - UT-50563 - 1 LED - 2 W - 23° - 4000K - On/Off - Matt Silver
UT-50563-N-W30-ND-05	UTAH 2 - UT-50563 - 1 LED - 2 W - 23° - 3000K - On/Off - Matt Silver
UT-50563-N-W40-DA-06	UTAH 2 - UT-50563 - 1 LED - 2 W - 23° - 4000K - DALI - Bronze
UT-50563-N-W30-DA-06	UTAH 2 - UT-50563 - 1 LED - 2 W - 23° - 3000K - DALI - Bronze

UTAH

UT-50563-N-W40-DI-03	UTAH 2 - UT-50563 - 1 LED - 2 W - 23° - 4000K - 1-10V - White
UT-50563-N-W30-DI-03	UTAH 2 - UT-50563 - 1 LED - 2 W - 23° - 3000K - 1-10V - White
UT-50555-E-40-02	UTAH 3 - UT-50555 - 1 LED - 5 W - 23°x 43° - RGBW40 - DMX - Dark Grey
UT-50555-E-30-02	UTAH 3 - UT-50555 - 1 LED - 5 W - 23°x 43° - RGBW30 - DMX - Dark Grey
UT-50555-E-40-05	UTAH 3 - UT-50555 - 1 LED - 5 W - 23°x 43° - RGBW40 - DMX - Matt Silver
UT-50555-E-30-05	UTAH 3 - UT-50555 - 1 LED - 5 W - 23°x 43° - RGBW30 - DMX - Matt Silver
UT-50555-E-40-03	UTAH 3 - UT-50555 - 1 LED - 5 W - 23°x 43° - RGBW40 - DMX - White
UT-50555-E-30-03	UTAH 3 - UT-50555 - 1 LED - 5 W - 23°x 43° - RGBW30 - DMX - White
UT-50555-E-40-01	UTAH 3 - UT-50555 - 1 LED - 5 W - 23°x 43° - RGBW40 - DMX - Black
UT-50555-E-30-01	UTAH 3 - UT-50555 - 1 LED - 5 W - 23°x 43° - RGBW30 - DMX - Black
UT-50555-E-40-06	UTAH 3 - UT-50555 - 1 LED - 5 W - 23°x 43° - RGBW40 - DMX - Bronze
UT-50555-E-30-06	UTAH 3 - UT-50555 - 1 LED - 5 W - 23°x 43° - RGBW30 - DMX - Bronze
UT-50555-M-30-03	UTAH 3 - UT-50555 - 1 LED - 5 W - 33° - RGBW30 - DMX - White
UT-50555-M-40-03	UTAH 3 - UT-50555 - 1 LED - 5 W - 33° - RGBW40 - DMX - White
UT-50555-M-30-05	UTAH 3 - UT-50555 - 1 LED - 5 W - 33° - RGBW30 - DMX - Matt Silver
UT-50555-M-40-05	UTAH 3 - UT-50555 - 1 LED - 5 W - 33° - RGBW40 - DMX - Matt Silver
UT-50555-M-30-06	UTAH 3 - UT-50555 - 1 LED - 5 W - 33° - RGBW30 - DMX - Bronze
UT-50555-M-40-06	UTAH 3 - UT-50555 - 1 LED - 5 W - 33° - RGBW40 - DMX - Bronze
UT-50555-M-30-02	UTAH 3 - UT-50555 - 1 LED - 5 W - 33° - RGBW30 - DMX - Dark Grey
UT-50555-M-40-02	UTAH 3 - UT-50555 - 1 LED - 5 W - 33° - RGBW40 - DMX - Dark Grey
UT-50555-M-30-01	UTAH 3 - UT-50555 - 1 LED - 5 W - 33° - RGBW30 - DMX - Black
UT-50555-M-40-01	UTAH 3 - UT-50555 - 1 LED - 5 W - 33° - RGBW40 - DMX - Black
UT-50555-N-30-06	UTAH 3 - UT-50555 - 1 LED - 5 W - 18° - RGBW30 - DMX - Bronze
UT-50555-N-40-06	UTAH 3 - UT-50555 - 1 LED - 5 W - 18° - RGBW40 - DMX - Bronze
UT-50555-N-30-02	UTAH 3 - UT-50555 - 1 LED - 5 W - 18° - RGBW30 - DMX - Dark Grey
UT-50555-N-40-02	UTAH 3 - UT-50555 - 1 LED - 5 W - 18° - RGBW40 - DMX - Dark Grey
UT-50555-N-30-05	UTAH 3 - UT-50555 - 1 LED - 5 W - 18° - RGBW30 - DMX - Matt Silver
UT-50555-N-40-05	UTAH 3 - UT-50555 - 1 LED - 5 W - 18° - RGBW40 - DMX - Matt Silver
UT-50555-N-30-03	UTAH 3 - UT-50555 - 1 LED - 5 W - 18° - RGBW30 - DMX - White
UT-50555-N-40-03	UTAH 3 - UT-50555 - 1 LED - 5 W - 18° - RGBW40 - DMX - White
UT-50555-N-30-01	UTAH 3 - UT-50555 - 1 LED - 5 W - 18° - RGBW30 - DMX - Black
UT-50555-N-40-01	UTAH 3 - UT-50555 - 1 LED - 5 W - 18° - RGBW40 - DMX - Black
UT-50555-W-30-06	UTAH 3 - UT-50555 - 1 LED - 5 W - 50° - RGBW30 - DMX - Bronze
UT-50555-W-40-06	UTAH 3 - UT-50555 - 1 LED - 5 W - 50° - RGBW40 - DMX - Bronze
UT-50555-W-30-01	UTAH 3 - UT-50555 - 1 LED - 5 W - 50° - RGBW30 - DMX - Black
UT-50555-W-40-01	UTAH 3 - UT-50555 - 1 LED - 5 W - 50° - RGBW40 - DMX - Black
UT-50555-W-30-03	UTAH 3 - UT-50555 - 1 LED - 5 W - 50° - RGBW30 - DMX - White
UT-50555-W-40-03	UTAH 3 - UT-50555 - 1 LED - 5 W - 50° - RGBW40 - DMX - White
UT-50555-W-30-05	UTAH 3 - UT-50555 - 1 LED - 5 W - 50° - RGBW30 - DMX - Matt Silver
UT-50555-W-40-05	UTAH 3 - UT-50555 - 1 LED - 5 W - 50° - RGBW40 - DMX - Matt Silver
UT-50555-W-30-02	UTAH 3 - UT-50555 - 1 LED - 5 W - 50° - RGBW30 - DMX - Dark Grey
UT-50555-W-40-02	UTAH 3 - UT-50555 - 1 LED - 5 W - 50° - RGBW40 - DMX - Dark Grey
UT-50565-E-40-03	UTAH 4 - UT-50565 - 1 LED - 5 W - 23°x 43° - RGBW40 - DMX - White
UT-50565-E-30-03	UTAH 4 - UT-50565 - 1 LED - 5 W - 23°x 43° - RGBW30 - DMX - White
UT-50565-E-40-01	UTAH 4 - UT-50565 - 1 LED - 5 W - 23°x 43° - RGBW40 - DMX - Black
UT-50565-E-30-01	UTAH 4 - UT-50565 - 1 LED - 5 W - 23°x 43° - RGBW30 - DMX - Black
UT-50565-E-40-05	UTAH 4 - UT-50565 - 1 LED - 5 W - 23°x 43° - RGBW40 - DMX - Matt Silver
UT-50565-E-30-05	UTAH 4 - UT-50565 - 1 LED - 5 W - 23°x 43° - RGBW30 - DMX - Matt Silver
UT-50565-E-40-02	UTAH 4 - UT-50565 - 1 LED - 5 W - 23°x 43° - RGBW40 - DMX - Dark Grey
UT-50565-E-30-02	UTAH 4 - UT-50565 - 1 LED - 5 W - 23°x 43° - RGBW30 - DMX - Dark Grey
UT-50565-E-40-06	UTAH 4 - UT-50565 - 1 LED - 5 W - 23°x 43° - RGBW40 - DMX - Bronze
UT-50565-E-30-06	UTAH 4 - UT-50565 - 1 LED - 5 W - 23°x 43° - RGBW30 - DMX - Bronze
UT-50565-M-30-05	UTAH 4 - UT-50565 - 1 LED - 5 W - 33° - RGBW30 - DMX - Matt Silver
UT-50565-M-40-05	UTAH 4 - UT-50565 - 1 LED - 5 W - 33° - RGBW40 - DMX - Matt Silver
UT-50565-M-30-03	UTAH 4 - UT-50565 - 1 LED - 5 W - 33° - RGBW30 - DMX - White
UT-50565-M-40-03	UTAH 4 - UT-50565 - 1 LED - 5 W - 33° - RGBW40 - DMX - White
UT-50565-M-30-06	UTAH 4 - UT-50565 - 1 LED - 5 W - 33° - RGBW30 - DMX - Bronze
UT-50565-M-40-06	UTAH 4 - UT-50565 - 1 LED - 5 W - 33° - RGBW40 - DMX - Bronze
UT-50565-M-30-01	UTAH 4 - UT-50565 - 1 LED - 5 W - 33° - RGBW30 - DMX - Black
UT-50565-M-40-01	UTAH 4 - UT-50565 - 1 LED - 5 W - 33° - RGBW40 - DMX - Black

UTAH

UT-50565-M-30-02	UTAH 4 - UT-50565 - 1 LED - 5 W - 33° - RGBW30 - DMX - Dark Grey
UT-50565-M-40-02	UTAH 4 - UT-50565 - 1 LED - 5 W - 33° - RGBW40 - DMX - Dark Grey
UT-50565-N-40-02	UTAH 4 - UT-50565 - 1 LED - 5 W - 18° - RGBW40 - DMX - Dark Grey
UT-50565-N-30-02	UTAH 4 - UT-50565 - 1 LED - 5 W - 18° - RGBW30 - DMX - Dark Grey
UT-50565-N-40-06	UTAH 4 - UT-50565 - 1 LED - 5 W - 18° - RGBW40 - DMX - Bronze
UT-50565-N-30-06	UTAH 4 - UT-50565 - 1 LED - 5 W - 18° - RGBW30 - DMX - Bronze
UT-50565-N-40-05	UTAH 4 - UT-50565 - 1 LED - 5 W - 18° - RGBW40 - DMX - Matt Silver
UT-50565-N-30-05	UTAH 4 - UT-50565 - 1 LED - 5 W - 18° - RGBW30 - DMX - Matt Silver
UT-50565-N-40-01	UTAH 4 - UT-50565 - 1 LED - 5 W - 18° - RGBW40 - DMX - Black
UT-50565-N-30-01	UTAH 4 - UT-50565 - 1 LED - 5 W - 18° - RGBW30 - DMX - Black
UT-50565-N-40-03	UTAH 4 - UT-50565 - 1 LED - 5 W - 18° - RGBW40 - DMX - White
UT-50565-N-30-03	UTAH 4 - UT-50565 - 1 LED - 5 W - 18° - RGBW30 - DMX - White
UT-50565-W-40-05	UTAH 4 - UT-50565 - 1 LED - 5 W - 50° - RGBW40 - DMX - Matt Silver
UT-50565-W-30-05	UTAH 4 - UT-50565 - 1 LED - 5 W - 50° - RGBW30 - DMX - Matt Silver
UT-50565-W-40-03	UTAH 4 - UT-50565 - 1 LED - 5 W - 50° - RGBW40 - DMX - White
UT-50565-W-30-03	UTAH 4 - UT-50565 - 1 LED - 5 W - 50° - RGBW30 - DMX - White
UT-50565-W-40-02	UTAH 4 - UT-50565 - 1 LED - 5 W - 50° - RGBW40 - DMX - Dark Grey
UT-50565-W-30-02	UTAH 4 - UT-50565 - 1 LED - 5 W - 50° - RGBW30 - DMX - Dark Grey
UT-50565-W-40-06	UTAH 4 - UT-50565 - 1 LED - 5 W - 50° - RGBW40 - DMX - Bronze
UT-50565-W-30-06	UTAH 4 - UT-50565 - 1 LED - 5 W - 50° - RGBW30 - DMX - Bronze
UT-50565-W-40-01	UTAH 4 - UT-50565 - 1 LED - 5 W - 50° - RGBW40 - DMX - Black
UT-50565-W-30-01	UTAH 4 - UT-50565 - 1 LED - 5 W - 50° - RGBW30 - DMX - Black
UT-50572-M-W30-ND-01	UTAH ECO - UT-50572 - 1 LED - 7 W - 30° - 3000K - On/Off - Black
UT-50572-M-W40-ND-01	UTAH ECO - UT-50572 - 1 LED - 7 W - 30° - 4000K - On/Off - Black
UT-50572-W-W30-ND-01	UTAH ECO - UT-50572 - 1 LED - 7 W - 45° - 3000K - On/Off - Black
UT-50572-W-W40-ND-01	UTAH ECO - UT-50572 - 1 LED - 7 W - 45° - 4000K - On/Off - Black
UT-50572-VW-W30-ND-01	UTAH ECO - UT-50572 - 1 LED - 7 W - 60° - 3000K - On/Off - Black
UT-50572-VW-W40-ND-01	UTAH ECO - UT-50572 - 1 LED - 7 W - 60° - 4000K - On/Off - Black